

Article number: 54810052101

Description: 4 hole Flange Unit SSUCF210 for shaft $\varnothing 50\text{mm}$
Massive stainless steel, mat

Measures

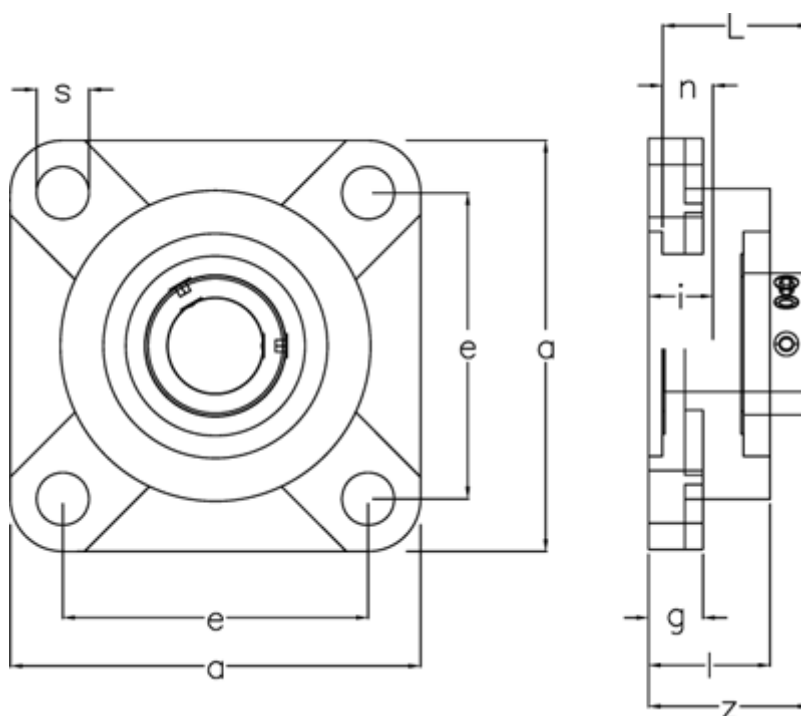

a	= 143	L	= 51.6
Bearing	= SUC210	Nominal drive	= 19.0
Bolt size	= M16	s	= 16
e	= 111	Weight	= 2.68
g	= 16.0	z	= 54.6
Housing	= SF210		
i	= 22		
l	= 40.0		